

IPv4 Header

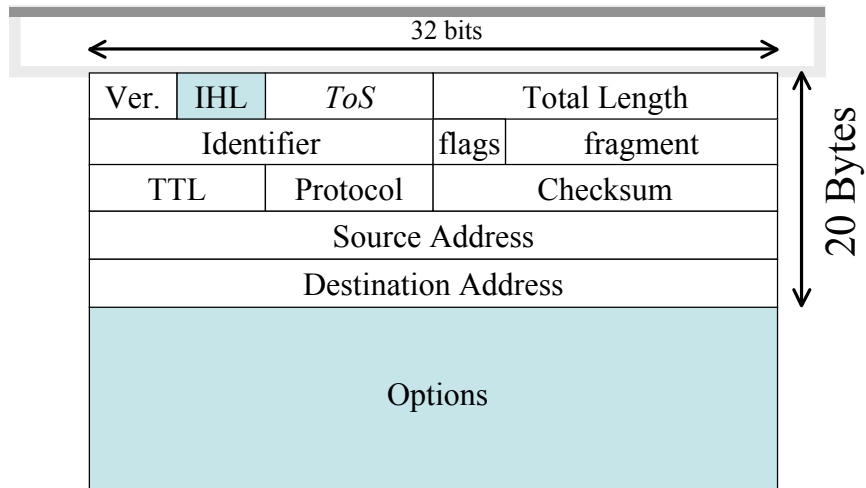

IPv4 Header

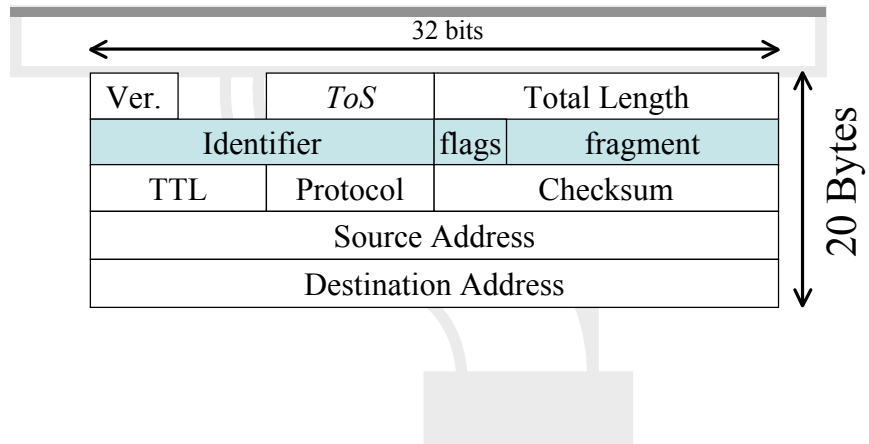

IPv4 Header

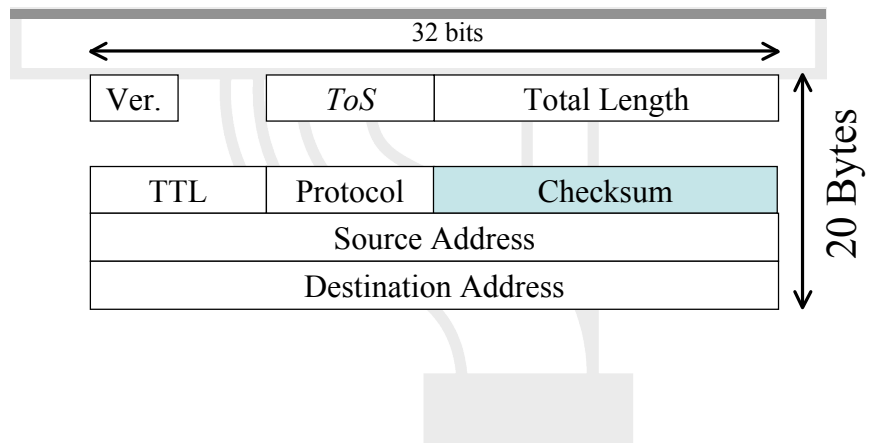

IPv6: Header simplification

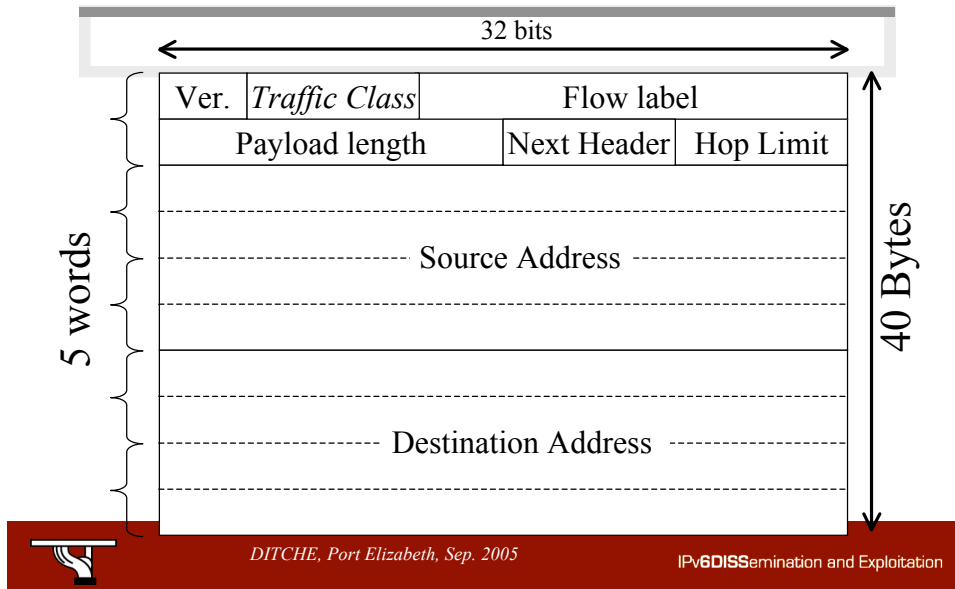

IPv6 header

- Version
- Traffic class
 - Next slide
- Flow label
 - RFC 3697
- Payload length
 - Use Jumbogram for specific cases (payload = 0)
- Hop limit
- Next header

CoS support in IPv6

- The **Traffic Class field**: *used as in IPv4*
 - Work done in diffserv wg (closed): RFCs **2474**, 2475, 2597, 3260, ...

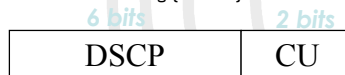

- The **Flow Label field**: designed to enable classification of packets belonging to a specific flow
 - A **flow** is a sequence of packets that should receive specific non-default handling from the network
 - Intuitively: 5-tuple of the same source/destination address/port and transport protocol values
 - Without the flow label the classifier must use transport next header value and port numbers
 - Less efficient (need to parse the option headers)
 - May be impossible (fragmentation or IPsec ESP)
 - Further info:
 - RFC 3697 (PS)



DITCHE, Port Elizabeth, Sep. 2005

IPv6DISSEmination and Exploitation

IPv6: Optional headers

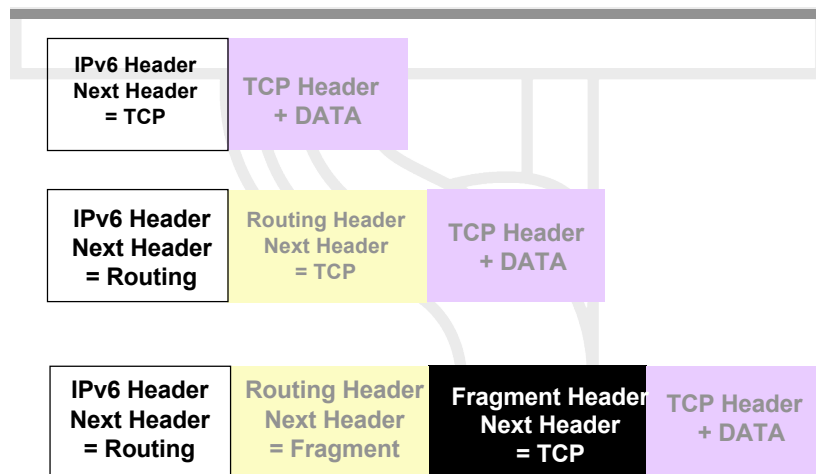

DITCHE, Port Elizabeth, Sep. 2005

IPv6DISSEmination and Exploitation

IPv6: Optional extensions

- Hop-by-hop (jumbogram, router alert)
 - Always the first extension
 - Replace IPv4 options,
 - Analyzed by every router.
- Destination
- Routing (loose source routing)
- Fragmentation
- Authentication
- Security



DITCHE, Port Elizabeth, Sep. 2005

IPv6DISSEmination and Exploitation

v4 options vs. v6 extensions

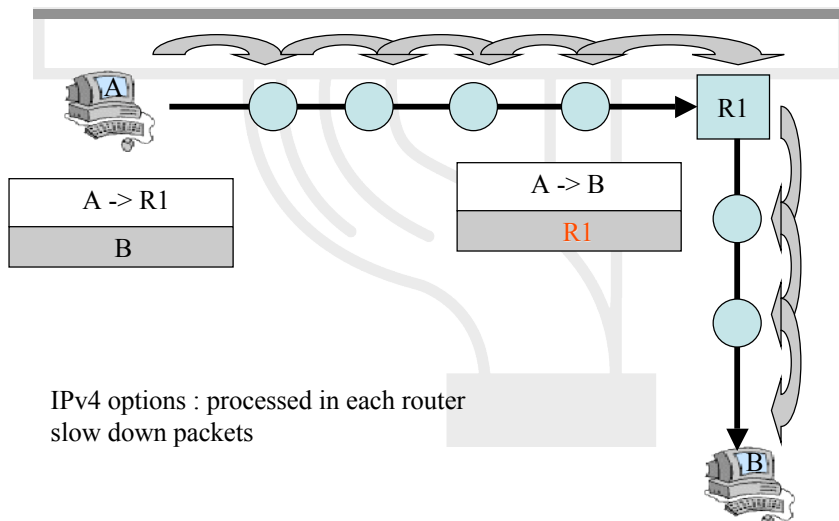

DITCHE, Port Elizabeth, Sep. 2005

IPv6DISSEmination and Exploitation

v4 options vs. v6 extensions

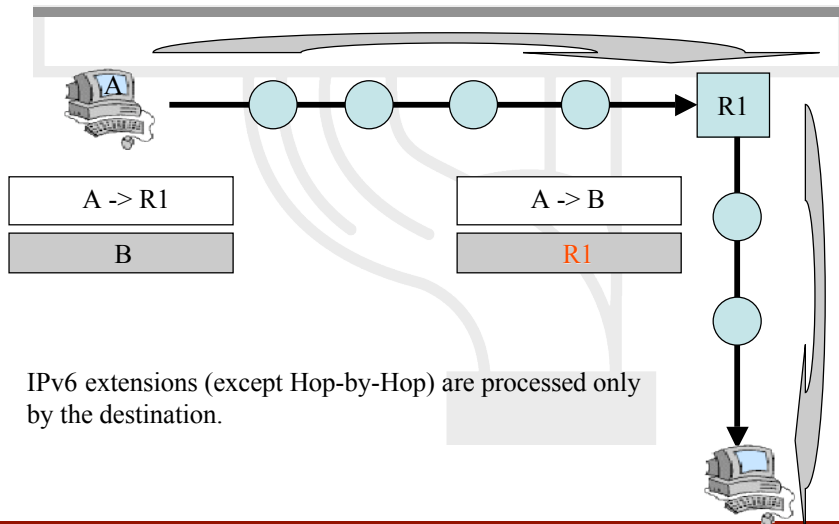

DITCHE, Port Elizabeth, Sep. 2005

IPv6DISSemination and Exploitation

Order is important (RFC 2460)

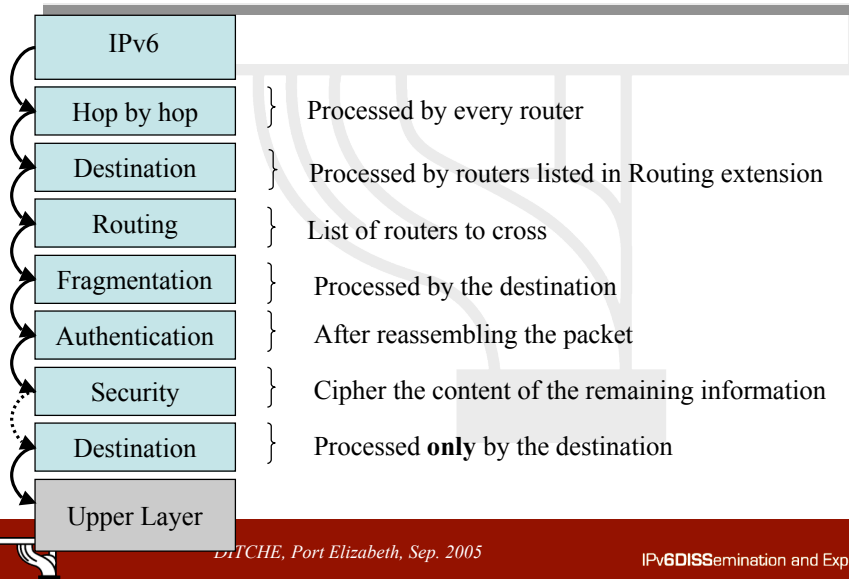

DITCHE, Port Elizabeth, Sep. 2005

IPv6DISSemination and Exploitation